

DLS Color Viewing Light v8 | XL

LED-based viewing booth, standard light luminaires D50, D65, UV-A and 2 alternatives



- LED-based viewing booth
- Article-No.: 203282/ 203283*

LED CONTROL

- Easy and intuitive operation
- External control optionally available (Art.-No. 203029)
- ALT1 and ALT2 is pre-programmed according to the request
- Mixed light function - several types of light can be selected simultaneously

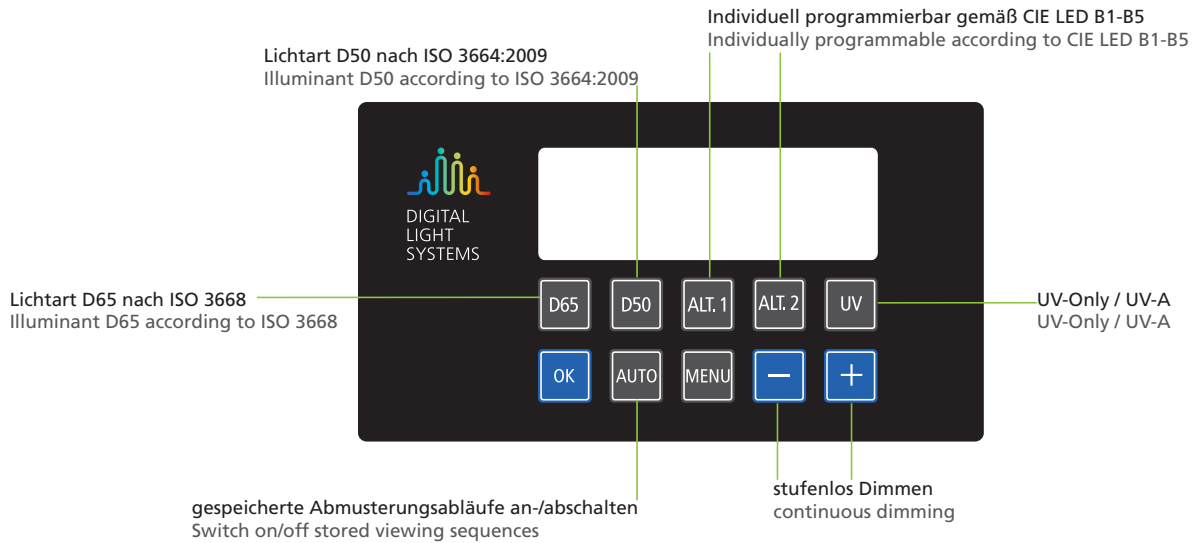

DIMENSIONS

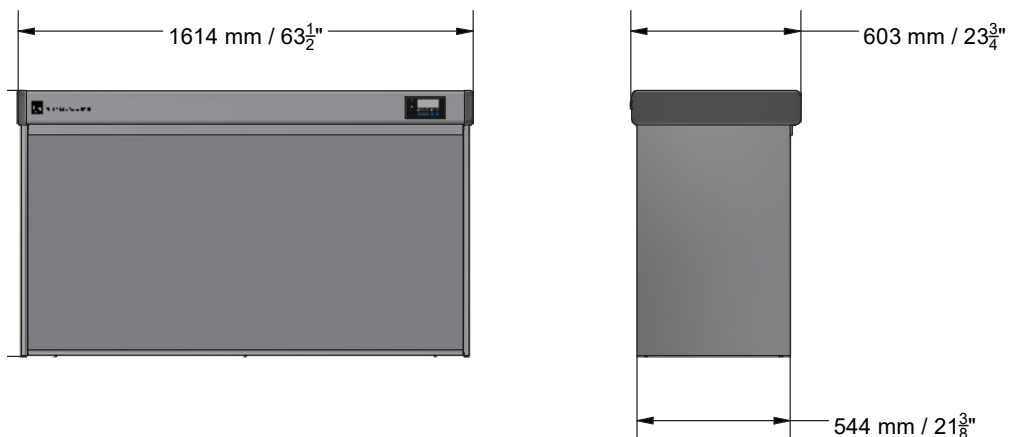

* Data for US version of the product

TECNICAL DATA

Electric data	
Maximum electric power	205 W
Electrical operating power	190 W
Operating voltage	230 V / 110 V*
Tension frequency	50 / 60 Hz
Connection cable	power cable, angle plug type 303 to IEC socket type 601 / NEMA 5-15P Male*
Maximum continuous current (continuous operation)	0,9 A / 1,9 A*
Operating mode	S1: Continuous operation
Expected lifetime (continuous operation)	>50.000 h

Photometric data and colormetric characteristics	
Illuminant types	CIE D50 (5000 K) , CIE D65 (6500 K), UV-ONLY (UV-A), CIE B1-B5 (2733 - 6598 K / Ra=80)
Ra (Color Rendering Index) \varnothing	>95
Metamerism Index (visible range)	$\leq 0,8$
Metamerism Index (UV-range)	$\leq 0,6$
Chromaticity error	<0,002
Chromaticity coordinate (10°)	D50: x = 0,3478 y = 0,3595 ($\leq 0,002$) D65: x = 0,3138 y = 0,3309 ($\leq 0,002$)
Dominant wavelength UV-ONLY	365 nm
Radiant power UV-ONLY	6 W
Risk assessment according to DIN-EN-62471	D65+UV / D50+UV: RG0 UV-ONLY: RG1

Mechanical data	
Illumination area (WxD)	155 x 54 cm 61" x 21 1/4"*
Outside dimensions (WxHxD)	162 x 95 x 60 cm 63 3/4" x 37 3/8" x 23 5/8"*
Product weight	34 kg 75 lbs
Housing	Aluminium
Lens	special prismatic lens, UV-transmissive
Protection class	IP 52
Permitted ambient temperature	0°C - 40°C / 32°F - 104°F

Environmental aspect (compared to conventional fluorescent lamps)	
CO ₂ -savings	over 17 tons

* Data for US version of the product

SPECTRES

Spectrum DLS Color Viewing Light D50

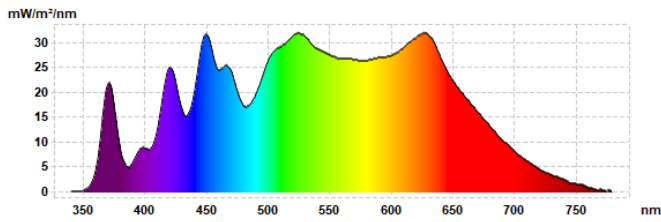

Spectrum DLS Color Viewing Light D65

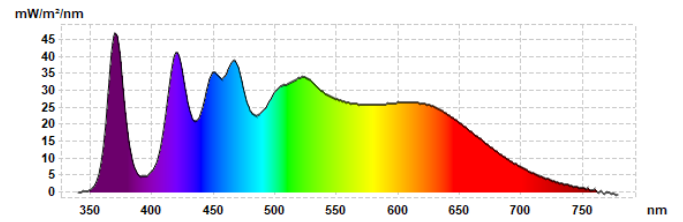

Spectrum UV-A (UV-Only)

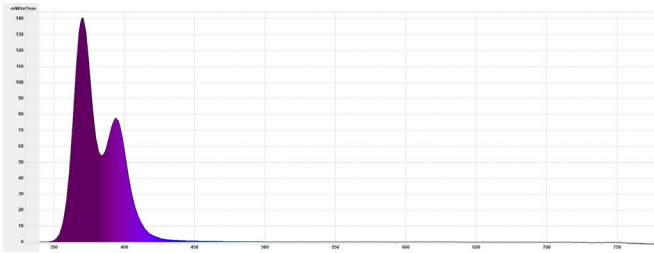

Spectrum DLS Color Viewing Light CIE B1

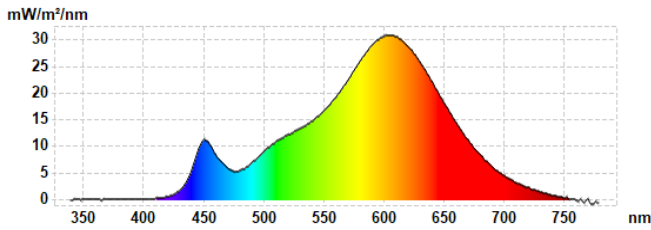

Spectrum DLS Color Viewing Light CIE B2

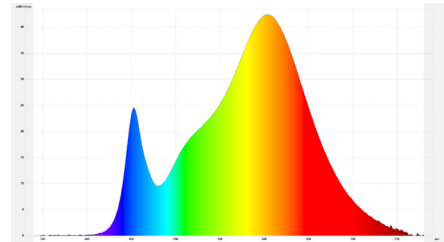

Spectrum DLS Color Viewing Light CIE B3

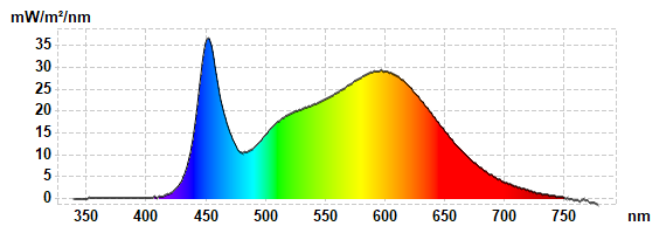

* Data for US version of the product

